



VENTILACIÓN

VENTILADOR VTHLE-LK 400^º/2h

Código Artículo: VTHLELK
01.08.2017

INFORMACIÓN TÉCNICA

Aplicaciones	Especialmente diseñados para cocinas industriales. Se utilizan para evacuar humos, 400 ^º /2h y extracción de aires o grasas.
Tipología	Ventilador centrífugo 400 ^º /2h a transmisión simple oído y turbina a reacción VTHLE-LK.
Materiales	Carcasa en chapa galvanizada.
Construcción	Envolvente con bastidor para mayor grado de rigidez del conjunto. Eje con chaveta incorporada y cojinetes preparados para trabajar hasta 100 ^º C en contínuo. Turbina de alta eficiencia.



MODELOS

250
280
315
355
400
450
500
560
630
710
800
900
1000

NORMATIVAS

400^º/2h: Homologación según Norma EN121014.3 por AFITI-LICOF con certificado nº 7962/01-2



VENTILACIÓN

VENTILADOR VTHLE-LK 400²/2h

Código Artículo: VTHLELK
01.08.2017

MEDIDAS

Tam.	A	B	B ₂	b ₁	C	ØD	Ød	Ød ₁	E	G	I	J	P	Q	R	S	T	W	W ₁	W ₂	W ₃	X	Y	h ₁	h ₂	h ₃	h ₄
250	420	218	193	170	462	250	20	8	4	275	36	53	384	43	25	325	15	224		80	118	43	242	195	225	188	273
280	467	247	217	188	518	280	25	10	4	270	35	59	432	38	30	364	15	278		77	120	43	242	215	252	211	307
315	520	270	240	210	578	315	25	1	4	320	40	70	480	50	30	406	15	278		101	150	45	290	236	283	235	345
355	583	314	274	235	656	355	30	10	4	310	40	70	542	50	40	456	20	354	95	151		59	271	261	320	266	390
400	654	341	301	262	735	400	30	10	4	335	48	70	606	50	40	508	20	354	126	191		61	294	290	366	300	436
450	726	373	333	295	828	450	35	12	6	340	52	70	674	50	40	566	20	450	112	189		61	299	322	406	336	492
500	800	408	368	330	918	500	35	12	6	340	56	80	744	50	40	638	20	490	127	214		57	303	352	448	374	544
560	892	467	417	370	1026	560	40	14	6	360	54	100	838	40	50	715	25	500	169	264		73	312	390	505	419	611
630	1000	510	460	412	1158	630	40	14	10	360	64	100	936	40	50	801	25	560	188	299		73	312	434	564	471	686
710	1160	560	510	462	1328	710	50	14	25	470	50	110	1110	50	50	905	25		392	253	140	105	390	515	642	534	798
800	1275	614	564	516	1490	800	50	14	25	470	40	110	1235	50	50	1005	25		449	274	151	105	390	553	722	600	890
900	1445	676	626	578	1675	900	60	14	25	520	50	110	1390	50	50	1125	25		500	307	175	105	440	635	810	675	1000
1000	1600	745	695	646	1857	1000	60	14	25	560	50	110	1550	50	50	1255	25		563	337	187	105	480	700	900	750	1107

250-315

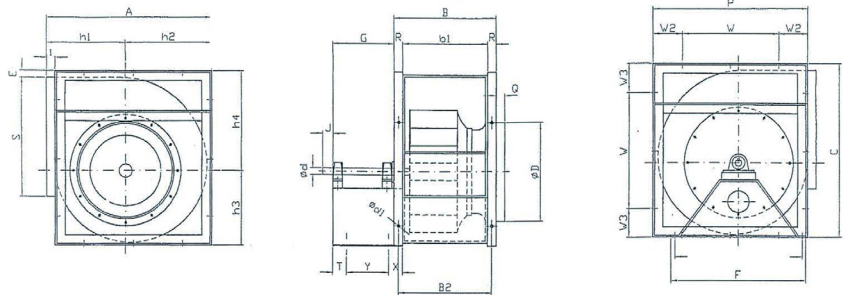

355-630

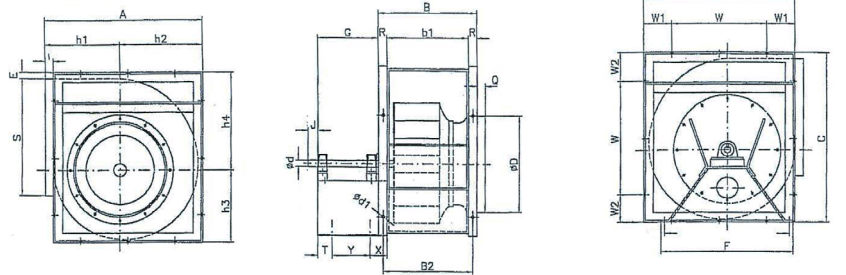

710-1000

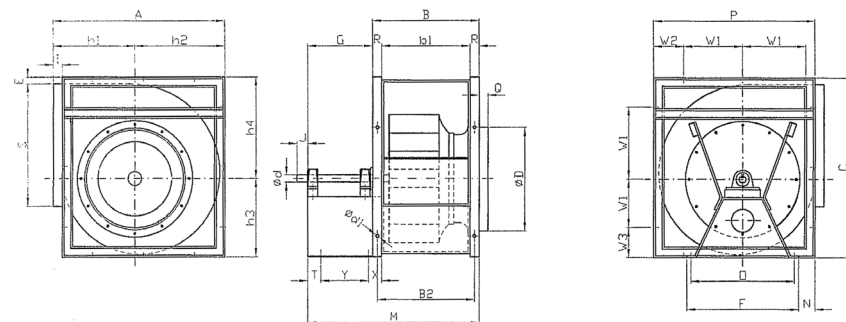



VENTILADOR VTHLE-LK 400⁰/2h

Código Artículo: VTHLELK
01.08.2017

CURVAS DE RENDIMIENTO

250

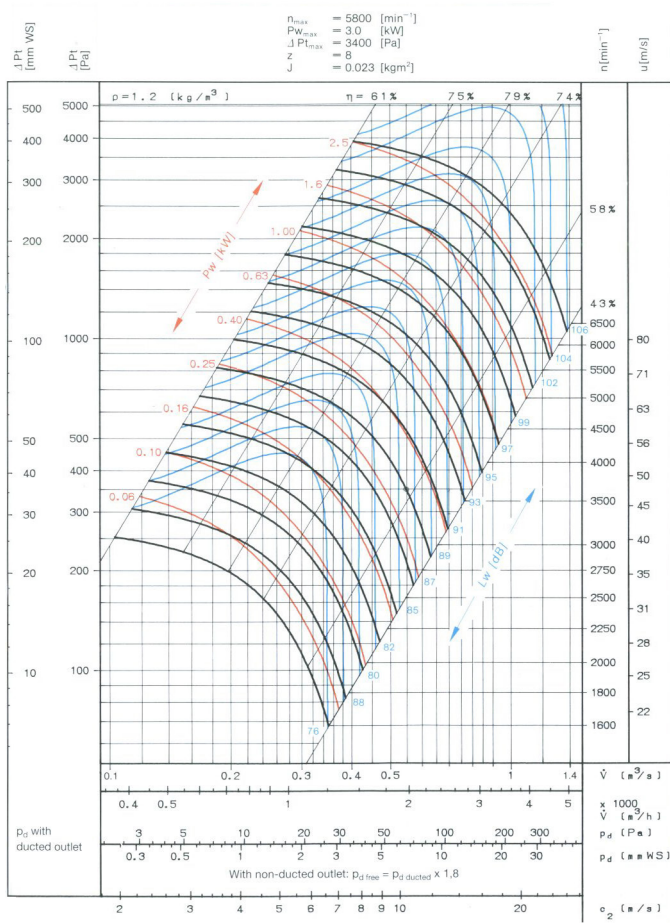

280

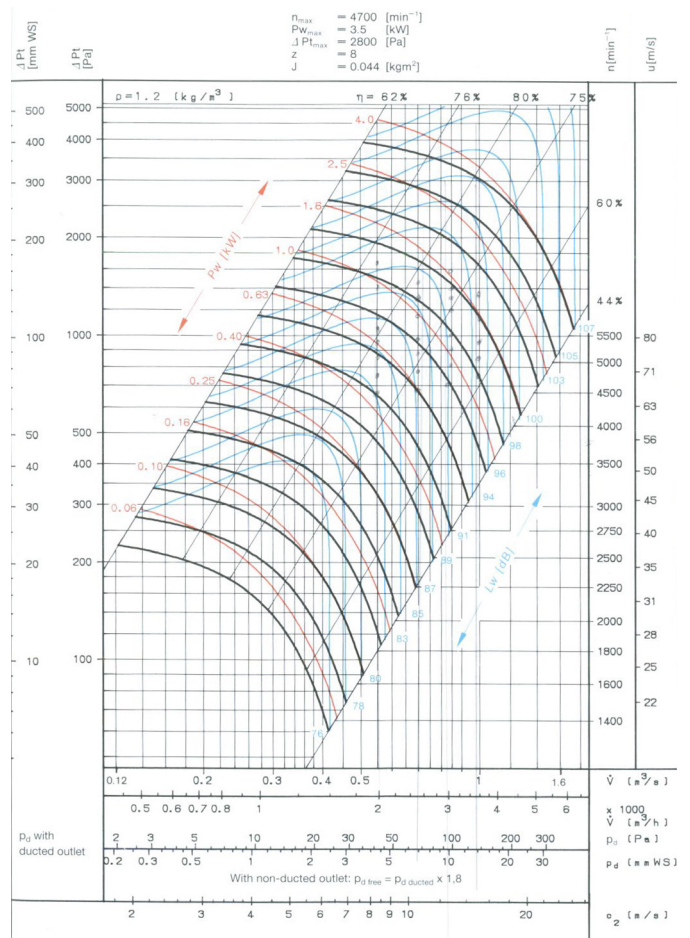

MORGUI CLIMA, S.L. se reserva el derecho de modificar sus productos y precios sin previo aviso. La garantía sólo cubre productos no utilizados y sin defectos causados por usos indebidos u ocasionados por el transporte.



VENTILADOR VTHLE-LK 400⁰/2h

Código Artículo: VTHLELK
01.08.2017

CURVAS DE RENDIMIENTO

400

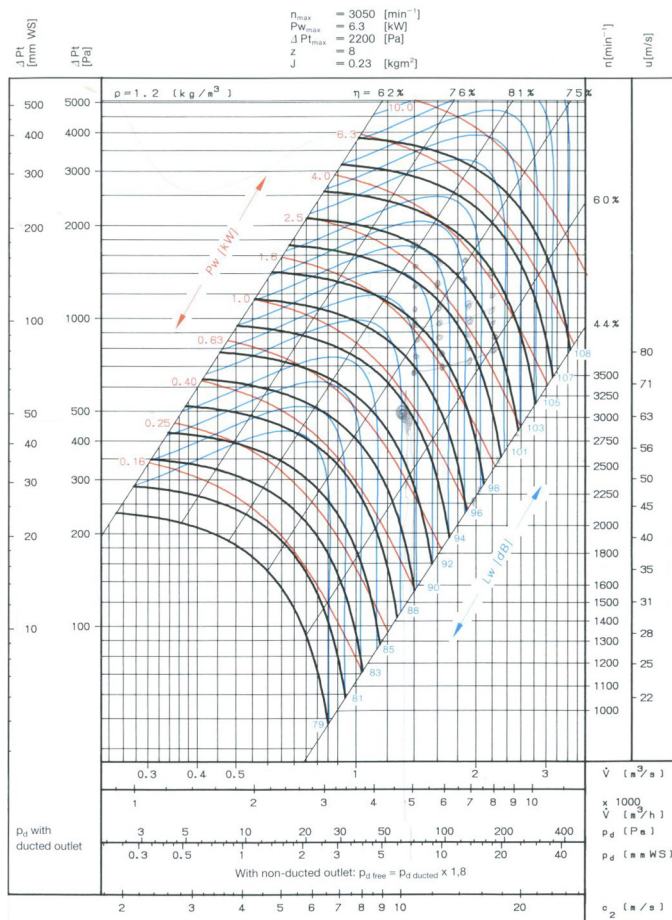

450

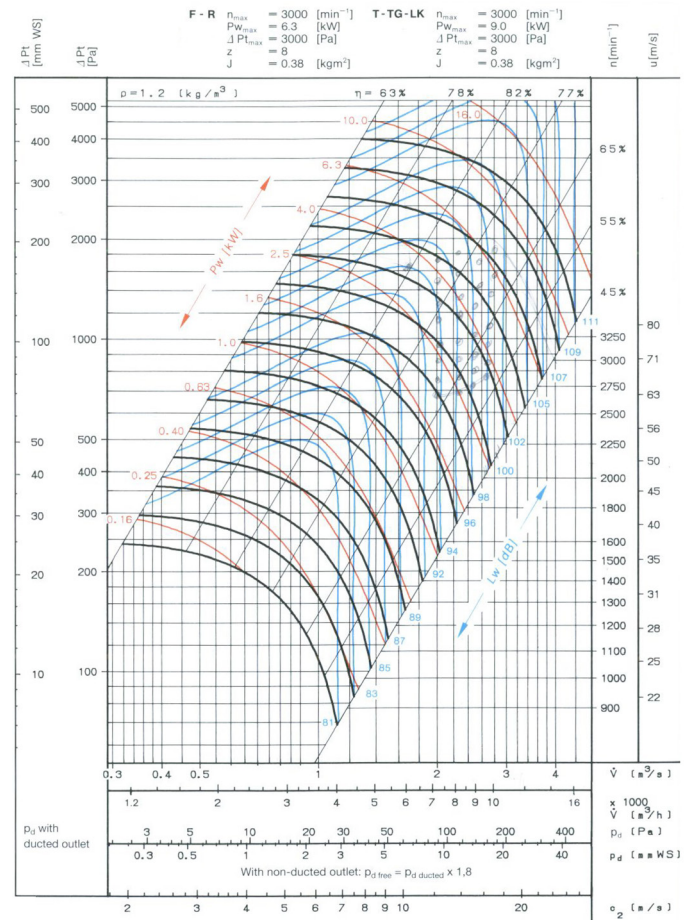



VENTILADOR VTHLE-LK 400⁰/2h

Código Artículo: VTHLELK
01.08.2017

CURVAS DE RENDIMIENTO

500

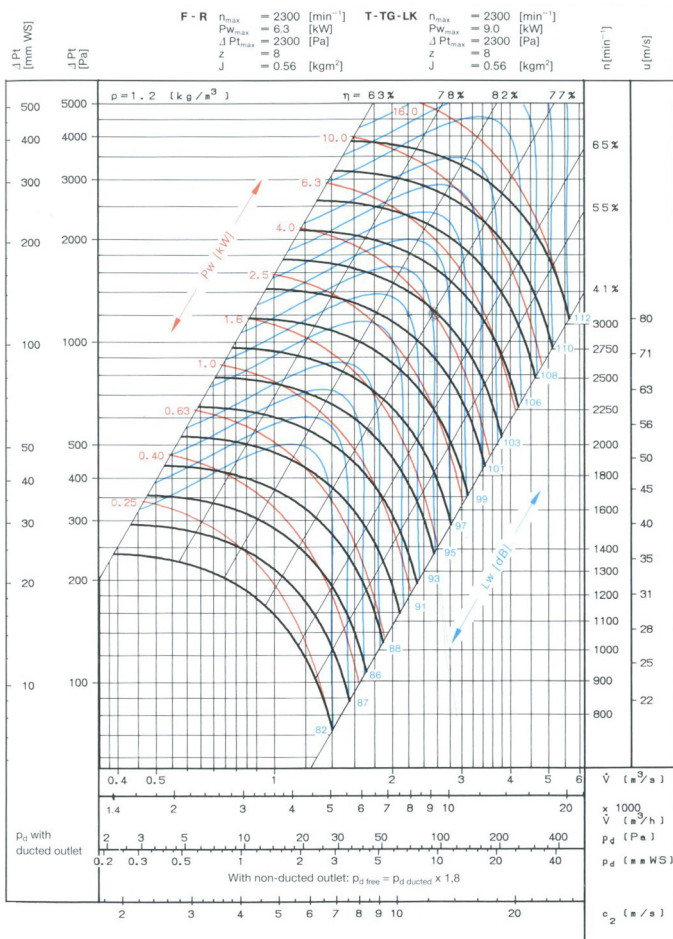

560

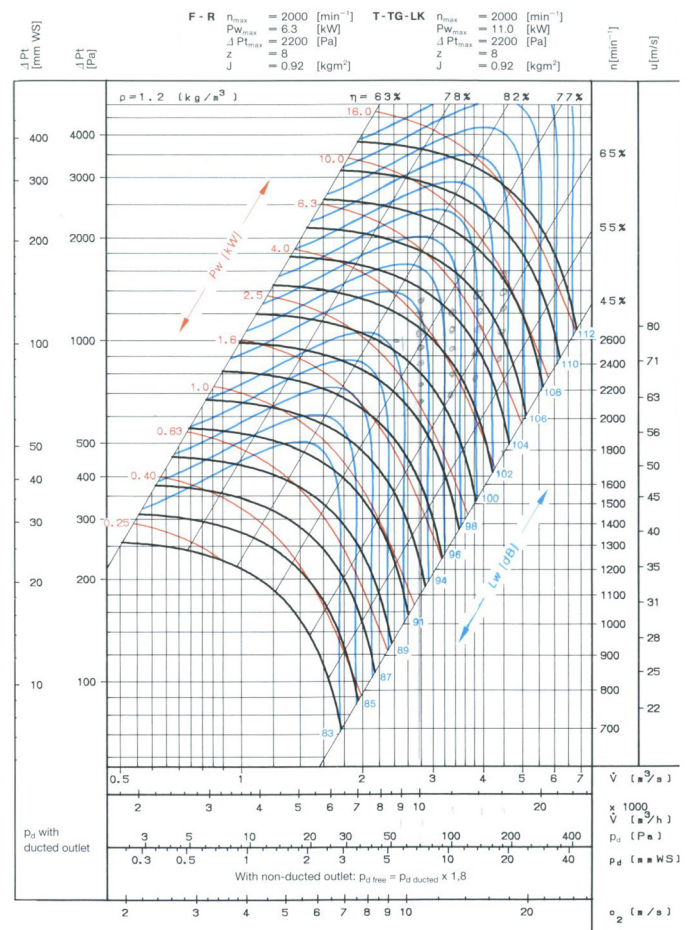

MORGUI CLIMA, S.L. se reserva el derecho de modificar sus productos y precios sin previo aviso. La garantía sólo cubre productos no utilizados y sin defectos causados por usos indebidos u ocasionados por el transporte.



VENTILACIÓN

VENTILADOR VTHLE-LK 400²/2h

Código Artículo: VTHLELK
01.08.2017

CURVAS DE RENDIMIENTO

630

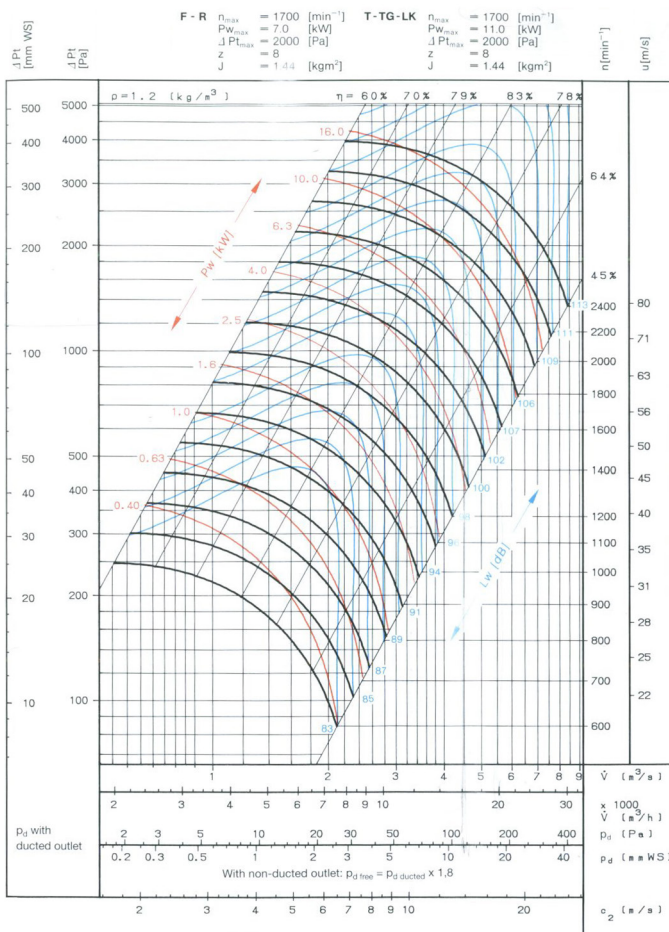

710

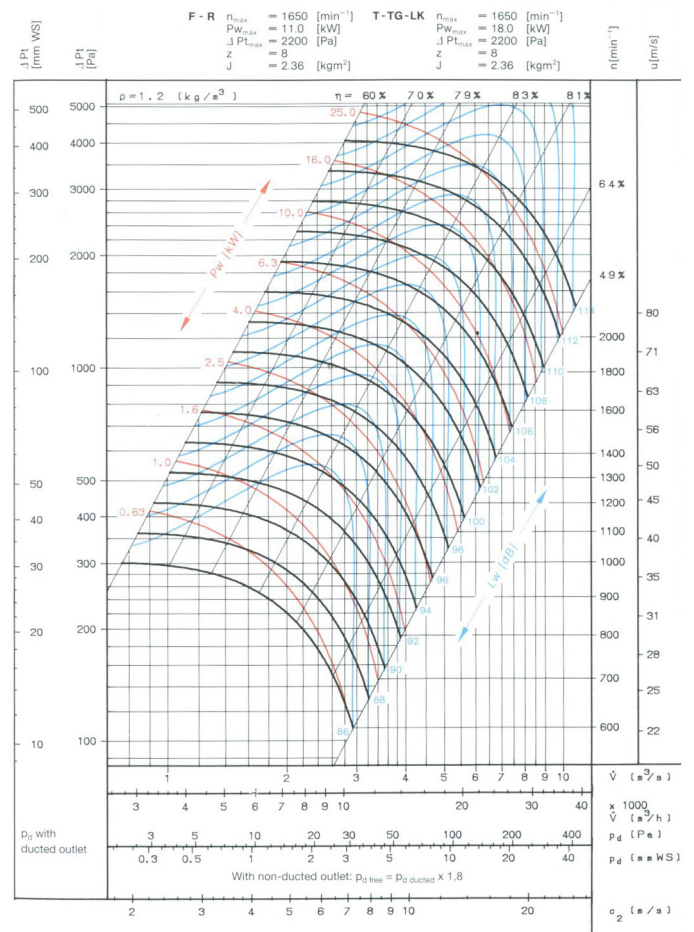

MORGUI CLIMA, S.L. se reserva el derecho de modificar sus productos y precios sin previo aviso. La garantía sólo cubre productos no utilizados por usos indebidos u ocasionados por el transporte.

