



REGULACIÓN

MOTORES ELÉCTRICOS

Código Artículo: VMOB
03.07.2019

INFORMACIÓN TÉCNICA

Descripción	Motores asíncronos trifásicos y monofásicos.
Tamaño	De 56 a 355.
Potencia	De 0,06 a 315kW para un servicio continuo (S1) a una tensión y frecuencia nominal.
Temperatura	Para una temperatura ambiente máximo de 40°C y una altitud máxima de 1.000m.
Velocidad	De una sola velocidad.
Polarización	2,4,6 y 8 polos.
Voltaje	a 230/400V o 400/690V.
Frecuencia	50Hz.
Aislamiento	Clase F y temperatura de calentamiento clase B.
Protección	IP55
Material	Carcasa (según serie): Aluminio o fundición. Eje: Acero Acabado: Pintura epoxy

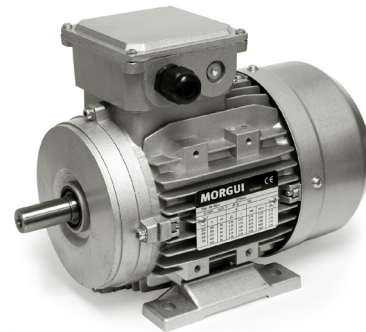

NORMATIVAS

Diseño según normas IEC 60034, IEC 60038 y IEC 60072.

FORMES CONSTRUCTIVES BÀSIQUES

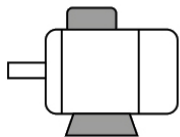

B3

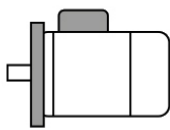

B5

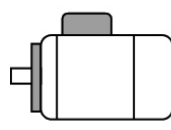

B14

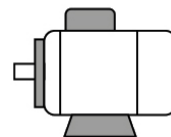

B3 / B14

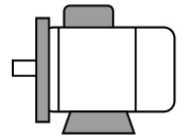

B3 / B5



REGULACIÓN

MOTORES ELÉCTRICOS

Código Artículo: VMOB
03.07.2019

DATOS NOMINALES MOTORES 4 POLOS - 1500 RPM - 50HZ

Tipo	Potencia nominal	Peso	Velocidad	PD rotor	Rendim.	Fact. pot.	Corr. nominal	Par nominal	Par de arranque	Corriente de arranque	Par máximo
<i>Típus</i>	<i>Potència nominal</i>	<i>Pes</i>	<i>Velocitat</i>	<i>PD rotor</i>	<i>Rendiment</i>	<i>Fact. pot.</i>	<i>Corr. nominal</i>	<i>P. nominal</i>	<i>Parell</i>	<i>Corrent d'arra.</i>	<i>P. màxim</i>
	[kW]	[CV]	[rpm]	[kgm ²]	η %	cos φ	a-at V.400 [A]	Cn [kgm]	d'arrancament Ca/Cn	la/ln	Cmax/Cn
56 A	0,06	0,08	3,2	1300	0,000050	47,3	0,65	0,27	0,043	1,6	2,0
56 B	0,09	0,12	3,4	1280	0,000054	47,9	0,73	0,37	0,069	1,6	2,0
63 A	0,12	0,16	4	1360	0,000091	45,2	0,70	0,50	0,086	1,8	1,9
63 B	0,18	0,25	4,5	1330	0,000106	52,7	0,70	0,69	0,130	1,8	2,0
71 A	0,25	0,35	6,1	1410	0,000331	58,6	0,67	0,91	0,172	1,8	2,0
71 B	0,37	0,5	6,7	1380	0,000367	60,6	0,72	1,20	0,262	2,0	2,2
80 A	0,55	0,75	8,9	1380	0,000899	67,7	0,74	1,58	0,389	2,0	2,2
80 B	0,75	1	9,6	1370	0,000991	66,7	0,76	2,03	0,542	2,0	2,2
90 S	1,1	1,5	12,5	1360	0,002166	74,3	0,79	2,71	0,770	2,1	2,4
90 L	1,5	2	15	1365	0,002576	75,1	0,78	3,66	1,059	2,1	2,4
100 L	2,2	3	19	1405	0,003076	80,4	0,79	4,98	1,534	2,4	2,7
100 Ld	3	4	22,5	1400	0,003691	81,2	0,84	6,40	2,076	2,4	2,6
112 M	4	5,5	39,3	1435	0,005101	83,1	0,82	8,37	2,701	2,2	2,4
132 S	5,5	7,5	50	1440	0,0091	83,3	0,84	11,23	3,688	2,2	2,4
132 M	7,5	10	53,5	1445	0,01	85,0	0,82	15,50	5,100	2,2	2,4
160 M	11	15	103	1440	0,18302	87,0	0,84	22,90	7,303	2,0	2,2
160 L	15	20	120	1440	0,2404	88,0	0,85	30,70	9,958	2,0	2,2
180 M	18,5	25	137	1460	0,40768	89,0	0,85	37,20	12,114	1,8	2,2
180 L	22	30	156	1460	0,5116	89,5	0,85	44,00	14,405	1,8	2,2
200 L	30	40	216	1470	0,87648	90,0	0,86	59,30	19,510	1,8	2,2
225 S	37	50	250	1465	1,3657	90,0	0,86	73,20	24,144	1,7	2,2
225 M	45	60	280	1465	1,63072	91,0	0,86	87,50	29,365	1,7	2,2
250 M	55	75	430	1460	2,8	90,0	0,88	105,00	35,366	2,5	2,6
280 S	75	100	530	1470	4,80	92,0	0,88	140,50	48,228	2,4	2,4
280 M	90	125	610	1470	6,00	92,0	0,90	164,50	57,873	1,9	2,0
315 S	110	150	780	1470	12,80	93,0	0,90	199,00	70,733	2,1	2,2
315 M	132	180	870	1470	14,60	93,0	0,88	244,50	84,850	2,3	2,3
315 L	160	220	1250	1475	16,80	94,0	0,88	293,00	102,855	2,3	2,6
315 Ld	200	270	1400	1475	20,00	94,0	0,88	366,50	128,606	2,3	2,4
355 L	250	340	1650	1487	8,62	95,0	0,85	446,90	162,327	2,8	2,3
355 Ld	315	430	1750	1478	10,50	95,0	0,85	563,00	205,777	3,0	2,3

MORGUI CLIMA, S.L. se reserva el derecho de modificar sus productos y precios sin previo aviso.



REGULACIÓN

MOTORES ELÉCTRICOS

Código Artículo: VMOB
03.07.2019

DIMENSIONES Y TAMAÑOS 56 ÷ 132

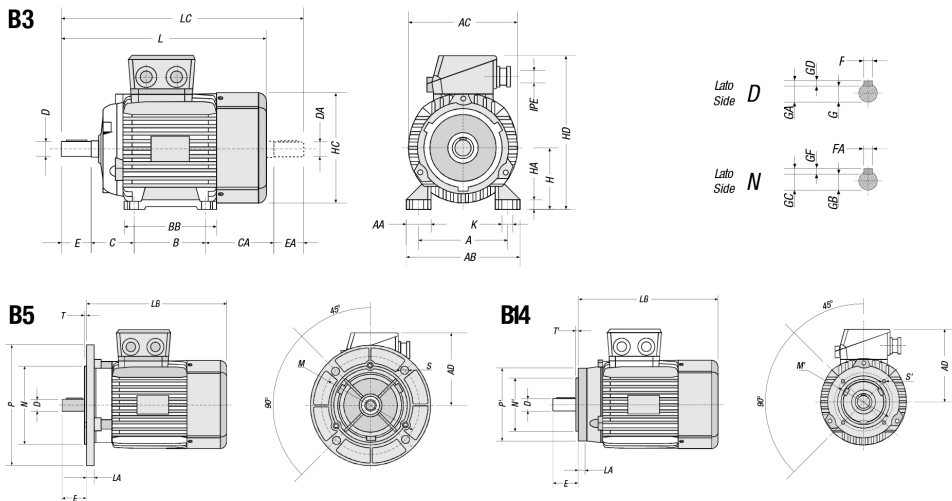

Tipo	Poli	AA	AB	AC	AD	BB	CA	DA	EA	FA	GB	GC	GF	HA	HC	HD	L	LA	LB	LC	Flangia B5	Flangia B14	IPE
56 A/B	2•4	18	108	108	92	85	78	9	20	3	7,2	10,2	3	8	111	148	199	10	179	225	F 100	F 65	1 x 9
63 A/B	2•4	26	120	120	99	96	71	11	23	4	8,5	12,5	4	10	123	162	208	10	185	237	F 115	F 75	1 x 13,5
71 A/B	2•6	31	132	130	104	106	77	14	30	5	11	16	5	10	136	175	236	10	206	272	F 130	F 85	1 x 13,5
80 A/B	2•8	31	150	146	124	120	84	14	30	5	11	16	5	10	153	204	268	12	228	304	F 165	F 100	1 x 16
90S	2•8	38	164	158	130	120	112	19	40	6	15,5	21,5	6	10	169	220	312	12	262	358	F 165	F 115	1 x 16
90L	2•8	38	164	158	130	145	107	19	40	6	15,5	21,5	6	10	169	220	332	12	282	378	F 165	F 115	1 x 16
100L	2•8	42	190	190	146	164	112	28	60	8	24	31	7	12	194	246	367	14	307	435	F 215	F 130	1 x 16
112M	2•8	46	220	216	165	164	124	28	60	8	24	31	7	13	220	277	384	14	324	454	F 215	F 130	1 x 21
132S	2•8	52	248	246	180	164	148	38	80	10	33	41	8	15	255	312	445	15	365	537	F 265	F 165	2 x 21
132M	2•8	52	248	246	180	202	148	38	80	10	33	41	8	15	255	312	483	15	403	575	F 265	F 165	2 x 21

Tipo	Poli	A	B	C	D	E	F	G	GA	GD	H	K	M	M'	N	N'	P	P'	S	S'	T	T'
56 A/B	2•4	90	71	36	9	20	3	7,2	10,2	3	56	5,8	100	65	80	50	120	80	7	M5	3	2,5
63 A/B	2•4	100	80	40	11	23	4	8,5	12,5	4	63	7	115	75	95	60	140	90	10	M5	3	2,5
71 A/B	2•6	112	90	45	14	30	5	11	16	5	71	7	130	85	110	70	160	105	10	M6	3,5	2,5
80 A/B	2•8	125	100	50	19	40	6	15,5	21,5	6	80	11	165	100	130	80	200	120	12	M6	3,5	3
90S	2•8	140	100	56	24	50	8	20	27	7	90	10	165	115	130	95	200	140	12	M8	3,5	3
90L	2•8	140	125	56	24	50	8	20	27	7	90	10	165	115	130	95	200	140	12	M8	3,5	3
100L	2•8	160	140	63	28	60	8	24	31	7	100	12	215	130	180	110	250	160	15	M8	4	3,5
112M	2•8	190	140	70	28	60	8	24	31	7	112	12	215	130	180	110	250	160	15	M8	4	3,5
132S	2•8	216	140	89	38	80	10	33	41	8	132	12	265	165	230	130	300	200	15	M10	4	3,5
132M	2•8	216	178	89	38	80	10	33	41	8	132	12	265	165	230	130	300	200	15	M10	4	3,5





REGULACIÓN

MOTORES ELÉCTRICOS

Código Artículo: VMOB
03.07.2019

DIMENSIONES Y TAMAÑOS 160 ÷ 225

B3

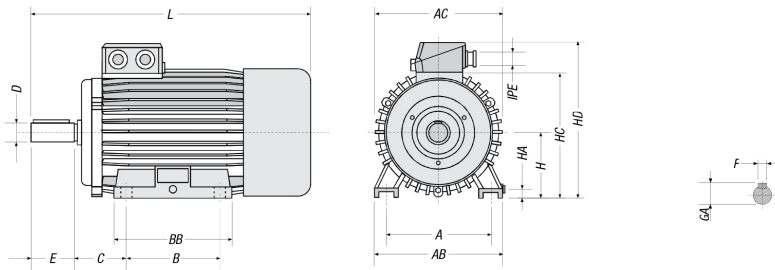

B5

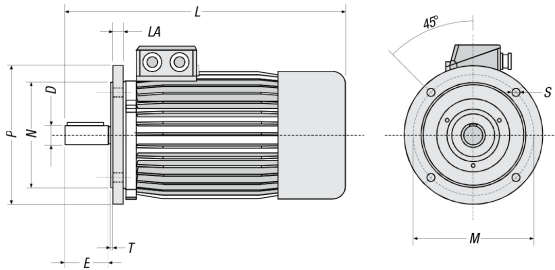

Tipo	Poli	A	B	C	D	E	H	K	M	N	P	F	GA
160M	2 • 8	254	210	108	42	110	160	15	300	250	350	12	45
160L	2 • 8	254	254	108	42	110	160	15	300	250	350	12	45
180M	2 • 8	279	241	121	48	110	180	15	300	250	350	14	51,5
180L	2 • 8	279	279	121	48	110	180	15	300	250	350	14	51,5
200L	2 • 8	318	305	133	55	110	200	19	350	300	400	16	59
225S	4 • 8	356	286	149	60	140	225	19	400	350	450	18	64
225M	2 4 • 8	356	311	149	55 60	110 140	225	19	400	350	450	16 18	59 64

Tipo	Poli	S	T	AB	AC	BB	HA	HC	HD	L	LA	Flangia B5	IPE
160M	2 • 8	19	5	324	325	260	25	320	380	609	13	F 300	2 x 21
160L	2 • 8	19	5	324	325	304	25	320	380	653	13	F 300	2 x 21
180M	2 • 8	19	5	349	352	300	25	357	412	659	13	F 300	2 x 29
180L	2 • 8	19	5	349	352	338	25	357	412	697	13	F 300	2 x 29
200L	2 • 8	19	5	393	395	360	30	397	457	779	15	F 350	2 x 36
225S	4 • 8	19	5	436	395	341	34	425	476	817	16	F 400	2 x 36
225M	2 4 • 8	19	5	436	395	366	34	425	476	809 847	16	F 400	2 x 36





REGULACIÓN

MOTORES ELÉCTRICOS

Código Artículo: VMOB
03.07.2019

DIMENSIONES Y TAMAÑOS 250 ÷ 315 Y 355

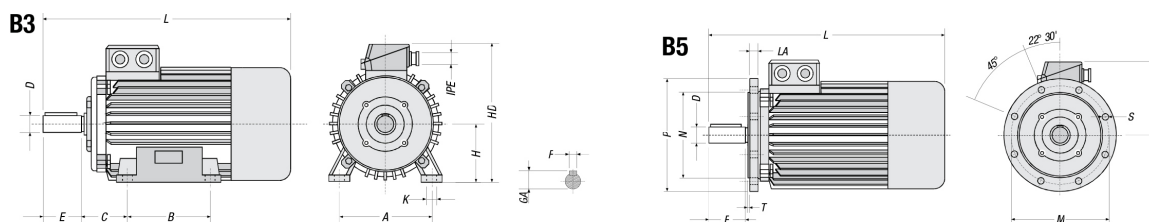

Tipo	Poli	A	B	C	D	E	F	GA	H	K	M	N	P	S	T	HD1	HD	L	Flangi B5	IPE
250M	2 4 • 8	406	349	168	60 65	140	18h9	64 69	250	24	500	450 j6	550	19	5	370	620	895	F 500	2 x 42
280S	2 4 • 8	457	368	190	65 75	140	18h9	69 79,5	280	24	500	450 j6	550	19	5	380	660	965	F 500	2 x 42
280M	2 4 • 8	457	419	190	65 75	140	18h9	69 79,5	280	24	500	450 j6	550	19	5	380	660	1045	F 500	2 x 42
315S	2 4 • 8	508	406	216	65 80	140 170	18h9 22h9	69 85	315	28	600	550 j6	660	24	6	400	715	1085	F 600	2 x 48
315M	2 4 • 8	508	457	216	65 80	140 170	18h9 22h9	69 85	315	28	600	550 j6	660	24	6	400	715	1125	F 600	2 x 48
315L	2 4 • 8	508	508	216	70 90	140 170	20h9 25h9	74,5 95	315	28	600	550 j6	660	24	6	496	811	1365	F 600	2 x 48

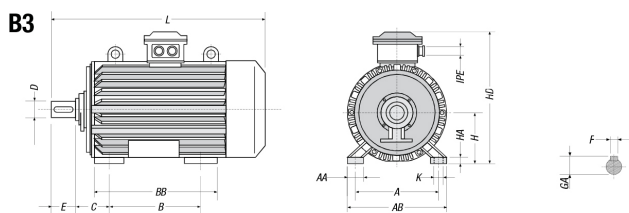

Tipo	Poli	A	B	C	D	E	F	GA	H	K	AA	AB	BB	HA	HD	L	IPE
355L	4 • 6	610	630	254	100	210	28	106	355	28	120	720	880	40	915	1480	2 x 60

